

Introduction to Sealants



In any glazing, waterproofing or sealing project, being fully informed is a major part of being prepared. This usually means a time and labor intensive struggle to gather material from manufacturers of competing products, only then to be faced with too many options.

C.R. Laurence Co. recognizes this, having been heavily involved in the sealants industry for many years, and has brought together the most complete and comprehensive sealant information you will find.

Here you will find information from the major sealant suppliers including; Dow Corning®, General Electric®, Tremco®, and our own **CRL Brand**. We cover a full range of technologies from the original patent silicone to the modern neutral cure system; from high performance polyurethanes to acrylics, butyl and latex caulking compounds, as well as other sealant and adhesive products. You will also find excellent information on dispensing systems and related accessories.

We believe you will appreciate our basic knowledge approach. For example, our coverage of Good Glazing Guidelines, or our Sealant Basic Uses and Limitations section is something you can give to your newer employees for their training (see pages N146 to N161).

CRL service is more than this. We also offer expert technical assistance. If you need more information, just call or go to our web site crlaurence.com. In an era when the major manufacturers are cutting back on customer service, CRL is expanding service! This is just our way of saying "Thank You" to our customers for your ongoing support.

Expert Sealant Assistance



Choosing the right sealant for the job calls for technical knowledge and professional experience. With so many different sealant applications, specifications, and products, choosing the best sealant involves balancing cost, performance, and suitability.

CRL is here to help. We employ full time sealant specialists who keep up to date with the ever-changing sealant market. Their job is to answer your questions, discuss all the options available, and help you make the right decisions about selecting and applying the sealants for your jobs. They are at your service all the way through the job for help with those tricky questions that inevitably come up on even the most thoroughly planned projects.

CRL's sealant assistance also includes our full line of sealants and related products. You can choose from such major brand names as **CRL**, Dow Corning®, General Electric®, Tremco®, and Dap. We stock silicones, polyurethanes, acrylics, butyls, and latex sealants in common construction colors.

Whether your project calls for 55 gallon drums, five gallon pails, two gallon pails, sausages, or standard cartridges, CRL can fill the need. Dispensing needs from hand-operated caulking guns to bulk dispensing pumps and accessories, solvents and cleaners, backer rods, and everything else you need to do the job right from start to finish are available from CRL.

Whatever your question, from selection to dispensing systems, from preparation to clean up, from MSDS to spec data sheets, CRL's sealant experts are as close as a toll free phone call (800) 421-6144, toll free fax (800) 262-3299, or visit us on the web at crlaurence.com.

Limitations of Warranties

All C.R. Laurence Company products and materials are sold subject to the terms and conditions set forth in our publications. All recommendations regarding such products are based on tests and examinations believed to be reliable, but C.R. Laurence Company neither guarantees nor warrants their accuracy or completeness.

It shall be the sole responsibility of the user to determine the suitability of the C.R. Laurence product or material for each intended use, and the user shall assume all

risks and liability in connection with the use, or inability to use, the product or material.

To the exclusion of all other remedies, C.R. Laurence Company warrants and agrees to replace, or at its sole option, to refund the purchase price of that portion of any material or product supplied by C.R. Laurence Company, which is proven upon inspection within thirty (30) days of the date of receipt of such product or material, to be defective in material or workmanship. No salesperson, agent, employee or representative of

C.R. Laurence Company has any authority to enlarge or change the terms of the warranty. In no event shall C.R. Laurence Company be responsible for any special, indirect, consequential or incidental damages or loss, including, without limitation, loss of profits or revenues, economic losses and loss of use, whether statutory or based on theories of contract or tort. There are no other agreements, express or implied (including any regarding merchantability or fitness for a particular purpose) not specified herein.

CRL Sealant Basic Uses and Limitations

The following is a summary of each of our CRL Construction Sealants with the basic uses and limitations for each. Unfortunately, no single glazing or construction sealant is right for every application. For example, some sealants can be painted while other sealants cannot. However, the sealant that cannot be painted usually has longer life expectancy than the sealant that can be painted. Some sealants are better suited for interior applications, while other sealants are able to perform in more demanding exterior applications. The exterior sealant costs considerably more than the sealant that is suitable for interior applications, however. How do you choose? Many times it comes down to trial and error, and your experience with different sealants over the years. The next few pages will help you select the CRL Sealants that fit the specific applications you have, and help you determine if the sealants you are using now are appropriate and comparable to our sealants.



33S
Silicone Sealant
(See page N108 for additional information)

Comparable Sealants

Dow Corning®: 999-A; 786; 732; 700; Trademate Glazing; General Purpose; Commercial Grade 100%; Tub, Tile & Ceramic, HVAC/R.
GE®: 1200 Construction, 1000 Contractors, 1700 Sanitary.
Tremco®: Proglaze, Tremsil 200, TremPro 644. **Pecora**®: 860, 863.
Sonneborn: OmniPlus.

CRL 33S Silicone

Description

This is an acetic cure, 100% high modulus, silicone sealant that delivers the performance you demand at a competitive price. Certified by NSF for food grade applications, UL Recognized, 24 month shelf life, and 10 year limited warranty. Qualifies for the **LEED**® (Leadership in Energy and Environmental Design) Green Building Rating System™ credit. **Our most popular sealant!**

Basic Uses

Glass, aluminum, metal alloys, stainless steel, wood, and plastics. Seals curtainwall joints, steel and aluminum windows, and skylights. Indoor uses include bathtubs, showers, and sanitary installations. Capable of ± 25% joint movement in a well-designed joint. Can be applied at outdoor temperatures as low as -35°F (-37°C) to +140°F (60°C), and withstands extreme temperatures after full cure from -80°F (-62°C) to +400°F (204°C).

Limitations

Not suitable for painting. Paint films bridge the sealant, but do not adhere to the silicone. Not recommended for structural glazing or insulating glass glazing, concrete and stone expansion joints, horizontal decks, patios, driveway or terrace joints where abrasion is possible, potable water applications or mirrors. Not recommended for surfaces with special protective or cosmetic coatings such as mirrors, reflective glass, teflon-coated, polyethylene or polypropylene surfaces. Check cartridge label and Specification Data Sheet for additional limitations.

CRL RTV408 Industrial and Construction Silicone



RTV408
Silicone Sealant
(See page N118 for additional information)

Comparable Sealants

Dow Corning®: 799; Trademate Vinyl Window, Siding & Door.
GE®: 2800 SilGlaze II. **Tremco**®: Tremsil 600, TremPro 645.
Pecora®: 896. **Novagard**®: Novaflex.

Description

Non-acetic neutral cure, low odor, 100% medium modulus silicone sealant that cures to a tough, flexible rubber. AAMA Approved, 12 month shelf life, and 20 year limited warranty. Qualifies for the **LEED**® (Leadership in Energy and Environmental Design) Green Building Rating System™ credit. Non-corrosive in contact with metals, and glazing I.G. units.

Basic Uses

Designed for joining most building materials including a variety of structural materials: glass, aluminum, stainless steel, ceramic, most reflective-coated glass, wood, and plastics. Seals curtainwall joints; vinyl, steel and aluminum windows; and skylights. Ideal for many in-house production applications. Suitable for alkaline materials such as mortar and cement. Non-corrosive to most building materials including insulating glass. Indoor uses include bathtubs, showers, and sanitary installations. Capable of ± 25% joint movement in a well-designed joint. Can be applied at outdoor temperatures as low as -20°F (-29°C) to +100°F (38°C), and withstands extreme temperatures after full cure from -65°F (-54°C) to +400°F (204°C).

Limitations

Not suitable for painting. Paint films bridge the sealant, but do not adhere to the silicone. Not recommended for structural glazing, concrete and stone expansion joints, horizontal decks, patios, driveway or terrace joints where abrasion is possible, food contact, potable water applications or mirrors. Neutral cure sealant cure byproducts may cause stress cracking or surface crazing of polycarbonate sheet under certain conditions. Check cartridge label and Specification Data Sheet for additional limitations.

CRL Sealant Basic Uses and Limitations



WCS1

Water Clear Silicone Sealant
(See page N113 for additional information)

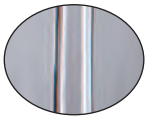
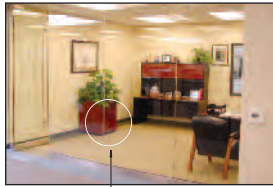

CRL
Water Clear

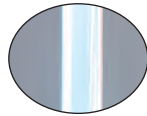
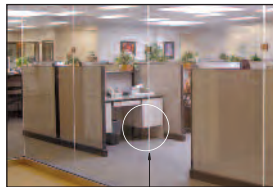

Typical Clear
(Translucent) Silicone

CRL Water Clear Silicone

Description

An optically clear, acetic cure 100% high modulus silicone sealant that cures in the presence of atmospheric moisture to produce a durable and flexible silicone rubber. It features a 12 month shelf life and 25 year limited warranty. It also qualifies for **LEED**® (Leadership in Energy and Environmental Design) Green Building Rating System™ credit (see page N159). By far, one of the clearest silicone available to the industry!

Basic Uses

Particularly effective for glazing butt and lap shear joints, sealing curtainwall projections and other glass, plastic, and metal assemblies. Its exceptional clarity makes it the ideal sealant to use in frameless shower enclosures, glass entries and partitions, specialty glass assemblies, and glass block installations. It adheres to clean metal, glass, most types of wood, silicone resin, ceramic, natural and synthetic fiber, and most painted surfaces. It is also appropriate for general construction and industrial applications.

Limitations

The exceptional clarity of this product will not hide application or tooling errors. A small amount of bubbles may form during the curing process of the sealant, so considerations should be made before use regarding standards of appearance and subsequent repairs (e.g., limited to sight lines). It is not recommended for use in the following applications: glazing or edge sealing of insulating glass; copper, brass, magnesium, zinc, galvanized surfaces. WCS1 is not mildew resistant. Check cartridge label and Specification Data Sheet for additional limitations.



95C

Silicone Building Sealant
(See page N120 for additional information)

CRL 95C Silicone Building Sealant

Description

Non-acetic neutral cure 100% low modulus silicone sealant that cures to a durable, flexible silicone rubber building joint seal. It features a 12 month shelf life with a 20 year limited warranty. It also qualifies for **LEED**® (Leadership in Energy and Environmental Design) Green Building Rating System™ credit (see page N159).

Basic Uses

It is designed for sealing expansion and control joints in precast concrete panels and metal curtainwalls; non-structural glazing of glass, metal, and plastic, as well as waterproofing applications, including perimeter sealing of doors and windows. Bonds with most building materials in any combination of glass, ceramics, plastics, stone, masonry, wood, steel, anodized and mill-finished aluminum, and painted surfaces. Compatible with all laminated glass, insulating glass units, and acrylic or polycarbonate glazing sheets. Capable of ± 50% joint movement in a well-designed joint. Can be applied at outdoor temperatures as low as -20°F (-29°C) to +130°F (54°C), and withstands extreme temperatures after full cure from -40°F (-40°C) to +350°F (177°C).

Limitations

Not suitable for painting. Paint films bridge the sealant, but do not adhere to the silicone. It is not recommended for structural glazing, sealing horizontal decks, patios, driveway or terrace joints where abrasion is possible, food contact, potable water applications, sealing below the waterline in marine applications, or mirrors. The cure byproducts of neutral cure sealants may cause stress cracking or surface crazing of the polycarbonate sheet under certain conditions. Check cartridge label and Specification Data Sheet for additional limitations.

Comparable Sealants

Dow Corning®: 795, 790, 791. **GE**®: SilPruf 2000, UltraPruf II 2900, SilPruf LM 2700. **Tremco**®: Spectrem 1, Spectrem II, Spectrem 3. **Pecora**®: 864, 895. **Sonneborn**: OmniSeal.

CRL Sealant Basic Uses and Limitations

CRL M64 Smooth and M66 Textured Polyurethanes

Description

Polyurethane sealant that cures in the presence of atmospheric moisture to produce a durable, flexible sealant for moving joints. Cures to either a smooth finish (M64) or light grainy textured finish (M66). AAMA approved, 12 month shelf life and five year limited warranty. Qualifies for the **LEED®** (Leadership in Energy and Environmental Design) Green Building Rating System™ credit.

Basic Uses

Developed for sealing dynamically moving joints, such as expansion and control joints, precast concrete panel joints, curtainwall joints, window and door frame perimeters, and similar types of construction joints. Adheres to common substrates such as brick, concrete, aluminum, vinyl, wood, and granite. Compatible with I.G. sealants when glazing units and applied as a toe or heel bead. Suitable for continual immersion in water with the use of the appropriate primer. Withstands temperatures after full cure from -40°F (-40°C) to +180°F (82°C). Paintable after full cure, minimum 72 hours. It is also appropriate for general construction and industrial applications.

Limitations

Do not apply over damp or contaminated surfaces. Use with adequate ventilation. Not recommended for surfaces with special protective or cosmetic coatings without prior consultation of the manufacturer. Should not be applied to unpredictably absorptive surfaces such as marble, limestone or granite unless a standard of appearance has been agreed on as a result of testing for stain and/or discoloration. Check cartridge label and Specification Data Sheet for additional limitations.



M64
Smooth Formula
Polyurethane



M66
Textured Formula
Polyurethane

(See pages N128-N129 for additional information)

Comparable Sealants

Dap: Premium Polyurethane. **Tremco®:** Vulkem 921, Vulkem 116, Dymonic, TremGlaze U1400, TremPro 626. **Sika:** 1A, 15LM, Sikaflex®-201 US, Sikaflex®-201 Textured, Sikaflex®-219 LM. **Sonneborn:** NP1. **Pecora:** Dynatrol 1-XL. **OSI:** PR-255. **Schnee Moorehead:** 7100. **Bostik:** Chem-Calk 900.

CRL M65W PermaWhite Polythane

Description

Modified polyurethane sealant with advanced non-yellowing formula and a smooth finish appearance. Low VOC and low odor; contains no isocyanates. Fast cure time allows painting in just two hours. 12 month shelf life and five year limited warranty. Qualifies for the **LEED®** (Leadership in Energy and Environmental Design) Green Building Rating System™ credit.

Basic Uses

Ideal for door and window frame perimeters. Specifically developed for sealing dynamically moving joints, such as: expansion and control joints, precast concrete panel joints, curtainwall joints, perimeter caulking (masonry, windows, doors, skylights, panels), bedding of mullions, panels, and frames. It is compatible with I.G. sealants when glazing units and applied as a toe or heel bead. Reduced fluid migration, or exudation, allows applications with new self-cleaning glass. Exhibits tenacious adhesion, which will not dissipate with time, to prepainted metals, plywood, glass, aluminum, steel, fiber cement, SMC, RIM, FRP, vinyl, and many plastics and composites. Capable of ± 25% joint movement in a well-designed joint. Withstands extreme temperatures after full cure from -30°F (-34°C) to +200°F (93°C).

Limitations

CRL M65W PermaWhite Polythane is not recommended for structural glazing, sealing horizontal decks, patios, driveway or terrace joints where abrasion is possible, food contact, potable water applications, sealing below the waterline in marine applications or mirrors. Do not apply over damp or contaminated surfaces. Not recommended for surfaces with special protective or cosmetic coatings without prior consultation of the manufacturer. Testing prior to painting with oil-based paints is recommended. Check cartridge label and Specification Data Sheet for additional limitations.



M65W
PermaWhite Polythane
(See page N127 for additional information)

Standard White Polyurethane

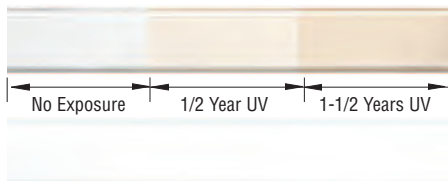

M65W PermaWhite Polythane

Comparable Sealants

Pecora: Pro-Sil1. **Tremco®:** Dymonic FC TremGlaze U1600. **Sonneborn:** Sonolastic 150. **Dap:** SIDE WINDER®.

CRL Sealant Basic Uses and Limitations



777

Butyl Rubber Sealant
(See page N136 for
additional information)

Comparable Sealants

CRL: 888. **Adco:** B-100, AP-77. **Dap:** BUTYL-FLEX®. **OSI:** SBR-100.
PTI: 757. **Pecora:** BC-158. **Tremco®:** Butyl Sealant.

CRL 777 Butyl Rubber

Description

Butyl based sealant is specially formulated using a blend of age resistant polymers to give excellent weathering properties at various temperature extremes. USDA Certified, AAMA 808.3 approved. It has a twelve month shelf life.

Basic Uses

CRL 777 Butyl Rubber is recommended for exterior applications and hidden areas, such as under sill cans, thresholds, and around screw heads. Other areas, such as between metal building panels, wall-mounted air conditioning units, under aluminum siding and gutters are all good applications for this proven butyl sealant. It has excellent adhesion to wood, masonry, glass, and metal surfaces, and is capable of ± 10% joint movement in a well-designed joint. It can be applied at outdoor temperatures as low as 0°F (-18°C) to +120°F (49°C), and withstands extreme temperatures after full cure from -20°F (-29°C) to +200°F (93°C). Paint time is 24 hours.

Limitations

CRL 777 Butyl Rubber is not recommended for use in sealing horizontal decks, patios, driveways or terrace joints where abrasion or physical abuse is encountered. Not recommended for surfaces with special protective or cosmetic coatings, and should not be applied with wet tooling techniques using solvents, water or detergent/soap solutions. CRL 777 has a solvent based curing system. A slight odor of mineral spirits will be detected during application, which is normal. Do not use where this odor may be objectionable, such as refrigeration units that will be stocked soon after construction. Check the cartridge label and Specification Data Sheet for additional limitations.



888

Butyl Rubber Sealant
(See page N137 for
additional information)

Comparable Sealants

CRL: 777. **Adco:** AP-77, B-100. **Dap:** BUTYL-FLEX®. **OSI:** SBR-100.
PTI: 757. **Pecora:** BC-158. **Tremco®:** Butyl Sealant.

CRL 888 Butyl Rubber

Description

A general purpose butyl-based sealant suitable for use in joints where economical, maintenance-free and watertight seals are desired. Non-stringy during application, and will not harden or crack with aging. AAMA 808.3 approved. It has a twelve month shelf life.

Basic Uses

It is recommended for caulking exterior and interior construction units, under thresholds and aluminum siding, between metal building panels and truck body joints, and many other areas. It is designed for use in joints of 3/8" (9.5 mm) or less in metal, glass, wood, plastic, and concrete. It can be applied at outdoor temperatures from 40°F (4°C) to +120°F (49°C), and withstands extreme temperatures after full cure from -20°F (-29°C) to +200°F (93°C). Paint time is 24 hours.

Limitations

CRL 888 Butyl Rubber is not recommended for use in sealing horizontal decks, patios, driveways or terrace joints where abrasion or physical abuse is encountered. It is also not recommended for surfaces with special protective or cosmetic coatings, and should not be applied with wet tooling techniques using solvents, water or detergent/soap solutions. Check the cartridge label and Specification Data Sheet for additional limitations.

CRL Sealant Basic Uses and Limitations



321
Siliconized Acrylic Latex
(See page N133 for additional information)



800
Acrylic Latex Caulk With Silicone
(See page N134 for additional information)

Comparable Sealants

Pecora®: AC-20. **Dap**®: Alex-Plus, Alex Fast Dry™, Dynaflex 230®.
OSI®: Polyseamseal Acrylic Caulk with Silicone, SA-167, Pro-Stik,
Sonneborn®: Sonolac. **Tremco**®: 834, TremGlaze SA1100, TremPro 655.

CRL 321 and 800 Acrylic Latex With Silicone

Description

These are premium quality acrylic latex caulks with silicone, featuring outstanding properties including adhesion, weather resistance, low shrinkage, water clean up, and more. The acrylic base offers outstanding adhesion and resistance to oxidation and ultraviolet rays. The siliconized feature improves the flexibility, and adhesion to ceramic and glass substrates. Both have a 12 month shelf life and 35 year limited warranty. Qualifies for **LEED**® (Leadership in Energy and Environmental Design) Green Building Rating System™ credit (see page N159).

Basic Uses

These can be used in areas with high moisture, such as showers, bathrooms, sinks, and kitchens, since it is mildew resistant and waterproof. Both offer excellent adhesion to aluminum, wood, concrete, glass, ceramic tiles, etc. They can be used for interior or exterior applications since it is odor free and offers superior weatherability, and are capable of ± 10% joint movement in a well-designed joint. They can be applied at outdoor temperatures as low as 40°F (4°C) to +120°F (49°C), and withstand extreme temperatures after full cure from 0°F (-17°C) to +180°F (82°C). Both can be painted with latex or oil-based paints.

Limitations

Neither should be used in applications that will be immersed in water. Should not be exposed to water or rain for at least 24 hours. Always apply when temperatures are above 40°F (4°C). Protect from freezing until fully cured. Check cartridge label and Specification Data Sheet for additional limitations.

CRL15W Acrylic Latex Caulk

Description

CRL15W Acrylic Latex Caulk is a superior quality acrylic latex caulk that guns with a creamy consistency. It is formulated to meet the needs of the professional or the do-it-yourselfer. It is easily cleaned with soap and water, and possesses a 12 month shelf life with a 25 year life expectancy. It also qualifies for **LEED**® (Leadership in Energy and Environmental Design) Green Building Rating System™ credit (see page N159).

Basic Uses

CRL15W Acrylic Latex Caulk is specially formulated for interior sealing around window frames, door frames, baseboards, moldings, plaster walls, etc. It adheres to plaster, drywall, painted and unpainted wood, masonry, and aluminum. It can be applied at outdoor temperatures as low as 40°F (5°C) to +90°F (32°C), and withstands extreme temperatures after full cure from 0°F (-18°C) to +200°F (94°C). It may be painted when a skin has formed, usually after two hours of application for latex paint or 24 hours if using oil-based paint.

Limitations

Maximum joint dimension is 1/2" x 1/2" (13 x 13 mm). Check cartridge label and Specification Data Sheet for additional limitations.



CRL15W
Acrylic Latex Caulk
(See page N135 for additional information)

Comparable Sealants

Red Devil®: Interior Wall & Wood.
Dap®: Alex® Painters, RELY-ON®. **OSI**®: LC-160.

Silicone Sealants are used in a wide variety of applications. Silicones have excellent resistance to the sun (UV) and weather. They are easy to apply in all temperatures, -35° to 130°F (-37° to 54.4°C), and exhibit very high heat as well as very low temperature stability, -80° to 400°F (-62° to 204°C); provide good adhesion to many substrates, especially glass; have very good joint movement capabilities from ± 25% to ± 50%; come with 10 to 20 year warranties and life expectancy of over 25 years; and good shelf life from one to two years. **NOTE:** Silicone sealants cannot be painted because paint typically beads up when applied to cured silicone.

CRL Special Properties of Silicones

- Excellent UV and Weather Resistance
- Long Life Reliability - 10 to 20 Year Warranty
- Stable Product - 1 to 2 Year Shelf Life
- Excellent Adhesion to Glass
- Remains Flexible and Easy to Apply Over a Wide Temperature Range

CRL Typical Applications of Silicones

Glazing

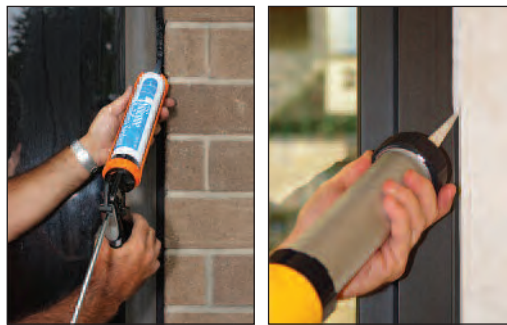

Conventional glazing of glass (cap, toe and heel beads); curtainwall sealing (projections, metal-to-metal joints); butt and lap shear joints; solar panels; replacement glazing.

Sealing Glass Butt Joints

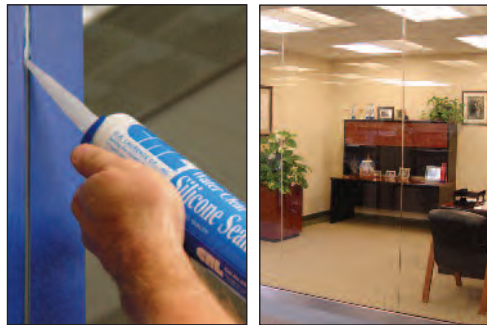

Glass butt joints; specialty glass assemblies.

Structural Glazing



Adheres glass, metal panels, or other cladding components to the building

Shower Enclosures and Tubs



Mildew-resistant silicone for sealing glass-to-glass, glass-to-metal, metal-to-fiberglass joints in frameless showers; tubs; sinks; ceramic tile, cultured marble top to back splash; spas.

Fabricating I.G. Units

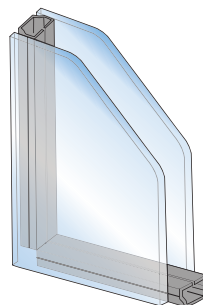

Fabricating Insulating Glass units with one or two-component silicone.

Manufacturing



Numerous applications when used as an adhesive.

CRL Special Properties of Construction Sealants

- Excellent Adhesion to Many Surfaces
- Lower Cost Than Construction Silicones
- Paintable
- Water-Based Available for Easy Clean Up
- Not Used for Structural Glazing

CRL Construction Sealants include Polyurethanes, Acrylic Latex with Silicone, and Butyl Rubber sealants. Polyurethanes are high performance sealants because of their joint movement capability of $\pm 25\%$ and higher. Because of their higher joint movement capability they can be used in many of the same applications as silicones (perimeter caulking around windows and doors, but not to glass), and typically at less cost. Polyurethanes offer excellent bonding to many surfaces and are paintable.

Acrylic Latex with Silicone caulks are water-based, making them easy to clean up. They are used mainly in residential and light commercial construction applications for both interior and exterior work because of their lower movement capability. They typically are paintable after only a short time.

Butyl Rubber Sealants have excellent adhesion to most substrates and exhibit excellent weathering, but because of their limited movement capability they are used in many low movement applications, like lap seams of metal panels, and concealed window frame joints. Butyl Rubber Sealants are also paintable after full cure.

CRL Typical Applications of Construction Sealants

Perimeter Caulking



Construction Polyurethanes for metal-to-concrete/brick storefronts, and residential vinyl window perimeter sealing.

Weatherproofing



Construction Polyurethanes for concrete-to-concrete expansion joints in tilt-ups, and other masonry joints.

Interior Caulking



Acrylic Latex Caulk with Silicone for interior gaps around window frames and baseboards; seals around tubs, sinks, back splashes, and toilets.

Metal Panels



Butyl Rubber Caulk for between metal building panels, aluminum siding, flashing, gutters, and other hidden areas.

The Full Service Sealant Source Selection

C.R. Laurence Company is a full service distributor of quality sealants. That means we stock dozens of sealants for use in the building, glazing, weatherization, and waterproofing trades. You can choose from our own quality CRL brands or from other major manufacturers' brands to get the right product for your application. We can also help you select the proper sealant. Our sealant experts can supply you with specifications and compatibility data on the full range of sealant products we stock.

Pricing

Full service also means sealant affordability. Volume distribution lets us keep our costs down, so you also benefit from our volume buying power. We know that you must be competitive in your market, and CRL's volume buying power helps you stay competitive. Sealant affordability, selection and availability, all from the CRL full service sealant source.

Availability

Full service means you can order the sealants you need, in the quantities you require, and get them expediently from your supplier. CRL offers sealants in drums, pails, cartridges, sausage packs, and squeeze tubes, along with dispensing equipment and tools to suit the application requirements of your job. Inventories are stocked in our regional warehouses for immediate pickup and shipment. Ordering is as simple as dialing our toll free fax or telephone numbers, or buying through our web site, crlaurence.com. Only CRL, the full service sealant supplier, offers you all of this.



Types and Movements of Sealants Most Commonly Used by Glazing Contractors

The following is a listing of all commonly used generic and non-generic sealant types. These listings cross-reference the sealants to their movement capability and to the architectural specification standard to which they conform.

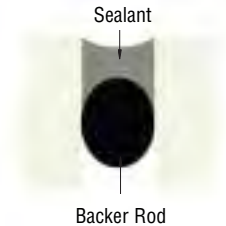

PRODUCTS	EXTENSION / COMPRESSION	ASTM / FEDERAL TEST
One-Part Silicone High Modulus Medium Modulus Low Modulus	25% / 25% 50% / 50% 100% / 50%	TT-S 001543 (COM-NBS) Class A, TT-S-00230C (COM-NBS) Class A, ASTM C-920 Type S, Grade NS, Class 25, Use NT, G, A; CAN/CGSB 19.13-M87.
One-Part Polyurethane	25% / 25%	TT-S-00230C, Type I and II, Class A; ASTM C-920-98, Type S, Grade NS or P, Class 25, Use NT, M, A, and O; CAN/CGSB 19.13-M87.
Two-Part Polyurethane	25% / 25%	TT-S-00227E, Class A, Type I and II; ASTM C-920, Type M, Grade NS or P, Class 25, Use NT, M, A, and O; CAN/CGSB 19.24-M90, Type I or II, Class B.
Acrylic Latex	10% / 10%	ASTM C-834
Butyl Rubber	10% / 10%	TT-S-001657, Type 1, TT-C00598C, TT-C-1796A, ASTM C-1311.

Class A ± 25% Joint Movement	Type S Single Component	Grade NS Non-Sag Material	Use G Glass
Class B ± 12.5% Joint Movement	Type I Non-Sag Material	Use NT Non-Traffic	Use A Aluminum
Class 25 ± 25% Joint Movement	Type II Self-Leveling Material	Use M Masonry	Use O Other

Guidelines to Good Glazing



Below are important guidelines to good glazing. By following these basic guidelines, you can be assured that every project will be completed with a good sealant installation. If you should have any questions regarding any of these general guidelines, please feel free to contact our Glass and Glazing Technical Sales at (800) 421-6144 in the U.S., (877) 421-6144 from Canada, or (323) 588-1281 International, and ask for Ext. 7720.

Glaze Above 40°F (4.4°C)

It is always a good practice to glaze above 40°F (4.4°C). Below this temperature condensation and frost can contaminate the surface and interfere with adhesion. If you must glaze in cold temperatures wipe all surfaces first with a recommended solvent, then wipe dry. Isopropyl alcohol and Methyl Ethyl Ketone (see page N251), are soluble in water and may be more appropriate for winter cleaning as they help remove condensation and frost. Xylene and Toluene are not soluble in water and may be better suited for warm weather cleaning. (See our Technical Article "Cold Weather Caulking" on page N149 for additional information.)

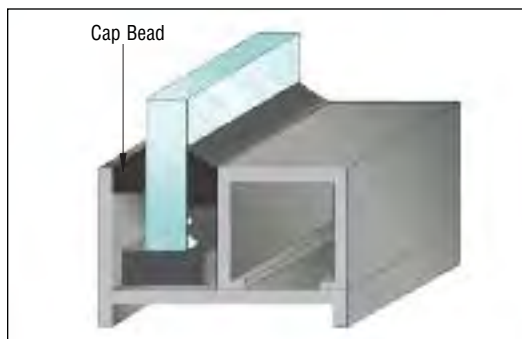

Form a Watershed

Gunnable sealants, when applied as a cap bead, should form a bevel or watershed away from the glass. When tape is used to the sightline, it should form a watershed when compressed. Do not undercut a sealant, compound, or tape below the sightline. Minimum cap bead depth should be from 1/4" to 3/8" (6 to 9.5 mm). For banded insulating units, a minimum of 1/8" (3 mm) sealant contact above the band is recommended. Tool and finish the sealant with a Tooling Spatula or Stick Tool as required. Do not use liquid tooling aids such as water, soap, or alcohol (such as IPA). These materials may interfere with sealant cure and adhesion, and may create aesthetic issues. (See our Technical Article "Surface Preparation and Proper Application" on pages N153-N155 for additional information.)

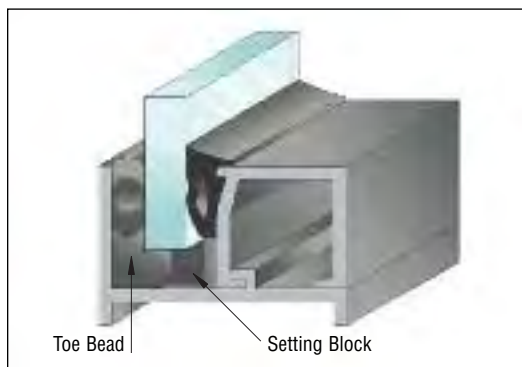

Achieve Positive Contact

When applying a heel bead, lap onto the glass a minimum of 3/16" (5 mm), and make certain of positive contact with the sash. When applying a toe bead, whether continuous or a corner seal, make certain it is large enough to contact both the glass and sash. The proper sequence is to install the sealant prior to glass placement.

Setting Blocks

Setting blocks should generally be made of Neoprene, EPDM or Silicone with a Shore "A" durometer from 80 to 90. When used in combination with heel and toe beads, they should be first buttered with sealant, then placed before installing the glass. This ensures an uninterrupted seal between glass and sash member.

As a general rule, setting blocks should be centered at quarter points. However, they can also be moved out to eighth points, or to a point 6" (152 mm) from the edge of the glass to the end of the setting block, whichever is greater.

Setting block widths should be 1/16" (1.6 mm) less than the full rabbet width, and high enough to provide the recommended minimum bite and minimum edge clearance for the glass. Length of setting blocks should not be less than 2" (51 mm).

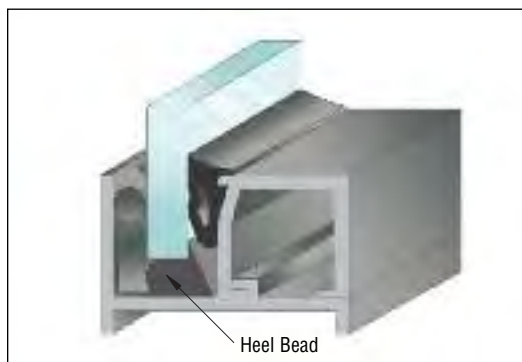

Surface Preparation

The key to good sealant adhesion is a clean surface. Clean the sash surface and glass edge just prior to glazing with proper cleaning solvents. Non-porous surfaces must be cleaned with a solvent before the sealant is applied. The solvent used will depend on the type of dirt or oil to be removed and the substrate to be cleaned. To avoid damaging the substrate, make sure that the cleaning procedures and solvents you are using are compatible with the substrate. Non-oily dirt and dust can usually be removed with a 50% solution of isopropyl alcohol (IPA) and water, a 70% solution of IPA and water (rubbing alcohol) or pure IPA. Oily dirt or films generally require a degreasing solvent such as Xylene or Methyl Ethyl Ketone (see page N251).

Guidelines to Good Glazing (Continued)



Be sure to use the "two-cloth" cleaning method, meaning a solvent wipe followed by a dry cloth wipe such as our Cat. No. 10522. Allowing solvent to dry on the surface without wiping with a second cloth negates the entire cleaning procedure, because the contaminants are re-deposited as the solvent dries. See our Technical Article "Surface Preparation and Proper Application" on pages N153-N155 for additional information. As work progresses, remove all excess sealant and smears with Cat. No. SR200 Silicone Remover and Surface Prep (see page N249).

Avoid Glass Damage

Glass should be carefully handled and glazed to avoid edge damage which can occur when units are rotated or "pitched" during positioning. One recommendation is the use of roller blocks (Cat. No. RB200) to rotate the glass unit. This minimizes possible corner damage by evenly distributing the glass weight along the edges, rather than at the corners.

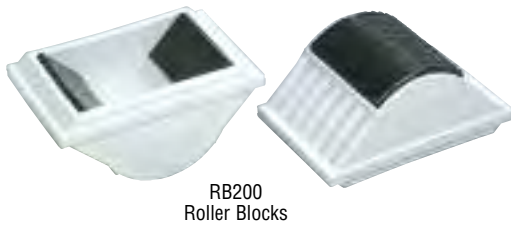

RB200
Roller Blocks

Shims and Setting Blocks/Spacers

Shims and setting blocks/spacers should be used, and are generally made from Neoprene or EPDM (Glazing Wedge Gasket), with a Shore "A" durometer hardness as recommended by the appropriate glass manufacturer. They can be either individually inserted shims, or preferably a continuous rod or wedge. Porous materials such as polyethylene and polyurethane foam are not suitable as shims.



Cross Section of Tape
Showing Shim

Tape Compression

Glazing tapes must be kept under proper compression. Depending upon the tape selected, this will vary from 10 to 50%.

Air Seal

When glazing a pressure-equalized system, it is necessary to install an interior air seal, or vapor barrier, around the perimeter of the glass unit. This equalizes pressure in the void around the edge of the unit with that of the building exterior. A heel bead of gunnable sealant accomplishes this best, since it readily bridges the space between the interior face of the glass unit and the sash.

Clearances

Observe minimum face clearance, edge clearance, and glass bite as recommended by the appropriate glass and sealant manufacturers. This allows the glass to freely float in the opening without undue restriction by the framing members, allowing the sealant to perform within its designed capabilities.

Weep Holes

When glazing insulating and laminated glass, the sill member must be wept to the exterior. A minimum of three weeps per sill, separated by the setting blocks, is recommended. Refer to the appropriate glass manufacturer for their recommended size and placement.

Tape Installation

Do not install glazing tapes more than one day ahead of glass placement. This helps avoid potential damage to the tapes by the other trades. Remove the release paper from the tape only when the lite is ready to be installed. Do not stretch the tape to make it fit. Do not overlap the ends of the tape. Instead, butt ends together, and when corners are butted together, dab with sealant to assure a positive seal.

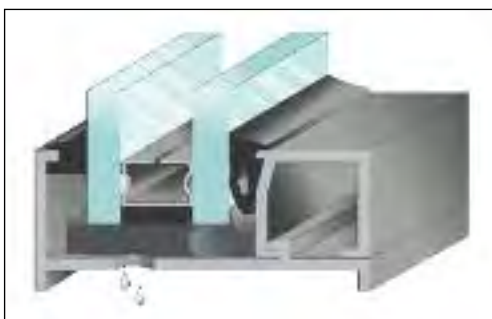

Guidelines to Good Glazing (Continued)

Insulating Units

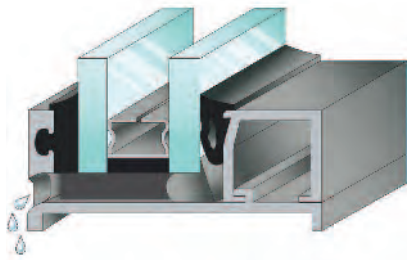

When Glazing Insulating Units:

- (1) Prevent water from standing in contact with the edge of the insulating unit, accomplished by incorporating weep holes in the sash design.
- (2) Provide a long-lasting cushion and seal between the insulating unit and the sash.
- (3) Glazing sealants must be fully compatible with sealants used in the fabrication of the insulating glass assembly. Deviation from these guidelines may ultimately lead to insulating glass failure.



The Glass Association of North America (GANA) has published a sealant manual for the glass and glazing community. The manual shows not only the types of sealants and their properties, but also illustrates details of joint types, has photos that guide you through compatibility and stain conditions, and explains the importance of sealants in restoration and protective glazing. The manual is for the use and guidance of commercial glazing contractors and architects in the commercial fenestration market. For copies of this manual email gana@glasswebsite.com or visit glasswebsite.com.



Follow Manufacturer's Specifications

Apply glazing sealants to the manufacturer's specifications. Use qualified installers who specialize in glazing and glass installation. Always report any unsatisfactory conditions, as soon as possible, to the general contractor for resolution before continuing.

Glazing Mock-up

Conduct an on-site glazing mock-up with the specified glazing components. Use the mock-up area as the "standard" for workmanship. It is recommended that the glazing system supplier be present during installation and testing.

If you have any questions or comments please contact the CRL Sealant Specialist.

Technical Article Cold Weather Caulking

The problem of low temperature work is related to three general situations, which may cause either difficulty in work or bad bonds, and these are:

- #1. The substrate may be covered with a film of ice – possibly too thin to be easily visible.
- #2. The sealant may be too cold to properly "wet down" to the substrate.
- #3. The sealant may be too stiff to gun or tool.

Of these, only the first is a real problem. The last two are solved simply by keeping the sealant at the suggested temperature range of 40° to 80°F (4° to 27°C) prior to use. We suggest that 60° to 80°F (16° to 27°C) is an ideal storage range. There are many mechanical means available for storage and maintenance of temperature.

The placement of a curing type sealant at a substrate temperature below 32°F (0°C) is always subject to the problem described in #1 above. If the sealant is cool it may not melt the ice film. Even if it does, the pressure may be gone and the resultant water film may remain intact and act as a barrier until it freezes again. In any event the application of curing sealants to wet substrates is not recommended.

Caulking can be done at low temperatures if proper care is taken to avoid the problems above. Necessary for good adhesion is that the substrate be clean and dry. This is easily accomplished by one of two methods:

- a) Flame dry the substrate and apply the "warm" sealant before the surface freezes again.
- b) Wipe the substrate clean of ice by use of methyl ethyl ketone (MEK), which is soluble in water and may be more appropriate for winter cleaning, as it helps in removing condensation and frost. Wire brush the surface immediately before application.

It should be noted that the curing time of sealants at 20°F (-7°C) is slowed to about one-third the normal rate.



Why Sealants Fail

Substrate Movement and Joint Design

To achieve proper joint design, two factors must be considered: the movement of the substrates, and the movement capabilities of the sealant. The information below is provided to help you determine these movements and select an adequate joint width for your application.

Substrate expansion of a 10 foot (3 m) length over a 100°F (55°C) temperature range:

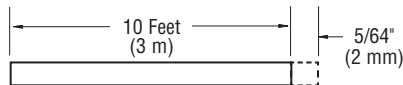

Glass, Limestone and Granite

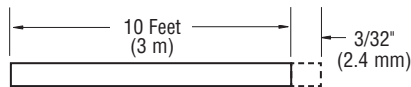

Concrete and Steel

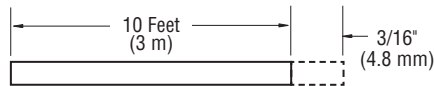

Aluminum

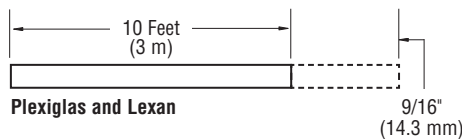

Plexiglas and Lexan

Movement to Joint Width Guideline:

10% Movement Materials – Butyl Rubbers and Acrylic Latex sealants. Movement x 10 = Joint Width.

25% Movement Materials – Polyurethanes and Silicones. Movement x 4 = Joint Width.

50% Movement Materials – Polyurethanes and Silicones. Movement x 2 = Joint Width

In Addition, the Following Should Also be Taken Into Consideration:

A minimum of 1/4" (6 mm) sealant substrate bond is necessary to ensure adequate adhesion.

One-part sealants require atmospheric moisture to fully cure. The sealant joint must be designed to ensure that the sealant is not isolated from the air.

A minimum 1/4" (6 mm) joint width is recommended. Wider joints accommodate more movement than narrow joints. As the sealant joint width becomes larger than 1" (25 mm), the depth should be held to approximately 3/8" (9.5 mm).

Three-sided adhesion limits the amount of movement that a joint can accept before failing. Three-sided adhesion can be eliminated by the addition of a bond breaker tape or backer rod.

A thin bead of sealant [1/4" ± 1/8" (6 ± 3 mm) depth] will accommodate more movement than a thick bead.

Optimum performance is also delivered when the sealant bead is shaped like an hourglass formed from round backer rod at the bottom and tooling the top with a rounded spatula tool.

Based on the above information, sometimes you will encounter a bad joint design in which no sealant will function properly. In these instances, contact the architect or general contractor to advise them of the poor joint design so they can take positive actions to resolve the design problems.

Substrate Movement During Cure:

One-part sealants cure by reacting with atmospheric moisture. Joint movement during cure can cause unsightly aesthetics due to joint wrinkling, and in some severe cases, cohesive failure of the sealant. Premature adhesion loss can also occur because the adhesive characteristics of the sealant are obtained after the sealant has cured. Adhesion loss due to movement during cure can be minimized by the use of a primer. Primers can decrease the adhesion cure time lag.

Minimize Wrinkling by Following These Suggestions:

Use open-cell polyurethane backer rod in vertical applications to allow air to the sealant from the back side to speed up curing time.

Apply sealant when the joint surface is cool and will experience minimum temperature changes, typically in the late afternoon or early evening.

Improper Surface Preparation:

All surfaces must be clean, dry, dust free and frost free prior to sealant application. This means removal of all dirt, dust, oils, and all other forms of surface contaminants prior to the application of any sealant materials.

Remove All Surface Contaminants:

- Sacking and dust from concrete.
- Concrete form-release agents, water repellents, surface treatments, protective coatings.
- Old sealants
- Oil from metals
- Surface protectors from metal or glass
- Dust from all surfaces



Improper Cleaning Solvents:

- Oil based solvents that leave a residue
- Soaps or detergents that leave a film
- Contaminated rags or wipes

Proper Cleaning Solvents:

50% solution of isopropyl alcohol (IPA) and water, 70% solution of IPA and water (rubbing alcohol) or pure IPA for non-oily dirt and dust.

Methylethylketone (MEK), Xylene or Toluene for oil and grease.

IPA and MEK are soluble in water and may be more appropriate for winter cleaning as they help in removing condensation and frost.

Use Primer When Required:

Certain substrates that chalk or oxidize require primer (see manufacturer's spec sheet).

Joints subject to water submersion. Surface condition at time of application: sealing to wet or frosty surfaces will cause sealant failure. See the Technical Article "Surface Preparation and Proper Application" on our web site for additional information.

Wrong Sealant Selection:

Incorrect sealant selection can and will lead to many sealant failures. Consult CRL's Product Manager for Construction Sealants to ensure the proper sealant is selected for your project. Listed below are some of the wrong applications.

Applications That are Sure to Cause Problems:

- Low performance sealants in high movement joints
- Using silicone sealant if surface is to be painted
- Butyl sealants on wide precast panel joints
- Urethane sealants on structural glazing
- Sealants in underwater applications
- Solvent based sealants to certain paints, plastics, and foams
- Silicone sealants to marble and natural stone (staining)
- Urethane or acrylic sealants as a glazing cap bead (UV breakdown)

Why Sealants Fail (Continued)

Incompatible Materials

Sealants may react with materials that are deemed to be incompatible with that sealant. If you're not sure of the compatibility of your sealant to a substrate, contact CRL's Sealant Specialist for clarification.

Some Incompatible Applications:

- Acetoxy silicone to copper
- Latex to bare steel
- All silicones to neoprene rubber
- Acetoxy silicone to most insulating glass sealants
- Solvent based sealants to plastic and rubber (test)

Poor Weather and/or UV Resistance

UV, ozone, and weather conditions are major factors in selecting the proper sealant. Jobs in large metropolitan areas are subject to smog and other airborne contaminants; jobs in rural areas are subject to temperature ranges that may exceed the manufacturer's suggested application range. If you need help in this area, feel free to call us, or you may reference the Specification Data Sheets for our sealants from the web site offer page for each sealant.

Applications to be Aware of:

- Low performance caulks have poor UV resistance
- Never apply caulks above/below the manufacturer's suggested application temperature range
- UV and ozone attack butyls, acrylics, and urethanes (chalking and crazing)

Using Material Beyond Its Shelf Life

All sealants have a published shelf life. A sealant that has exceeded the published shelf life may cause sealant failure if used without testing.

General Guidelines on Shelf Life:

- Oil based caulks and butyls - 12 months
- Acrylics and construction urethanes - 12 months
- Silicone (acetoxy) - 24 months
- Silicone (neutral cure) - 12 months
- Automotive urethanes - 9 months

Three Basic Types of Sealant Failure

Adhesive



"Loss of Adhesion" is failure of the sealant to adhere along the bond line of the surface to which it is attached, causing it to break away. Some possible causes are: joint movement exceeding the sealant capability, improper surface preparation, or improper bead configuration.

Cohesive



"Cohesive Failure" occurs when the sealant fails to hold together. Cohesive failure can take the form of splits and tears in both transverse and longitudinal directions. Usual causes include; improper sealant selection, poor mixing of multi-component sealants, possible air entrapment in the sealant from mixing, or improper bead configuration.

Substrate

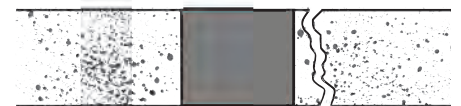

"Substrate Failure" is not a failure of the sealant itself, but of the surface or substrate to which it is supposed to adhere. Substrate failure results from improper surface preparation. The weak interface depicted here should have been saw cut back to prevent loose pieces of the surface material from breaking away from the joint interface.

Other Factors That Cause Sealant Failures: Poor Joint Design or Application

Failures occur when the design of the joint exceeds the ability of the sealant to function properly, or when the material is applied incorrectly or carelessly. Below is a guideline for basic **Do's** and **Don'ts**.

General Guidelines for Joint Designs

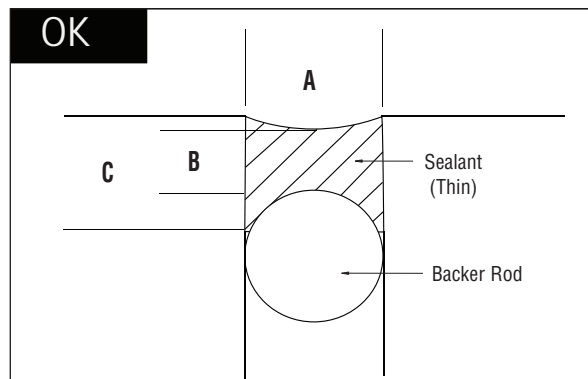

1. Dimensions C and A must be at least 1/4" (6 mm).
2. Ratio of A:B should be 2:1 minimum.
3. Joint surface tooled concave.
4. Dimension B suggested maximum is 3/8" (9.5 mm).

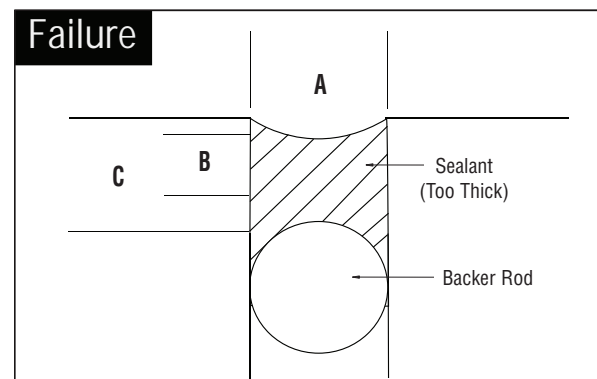

1. Deep sealant bead will not have same movement capability as properly designed thinner bead.
2. Slower cure time due to excessive sealant depth.

Why Sealants Fail (Continued)

Butt Joint Glazing

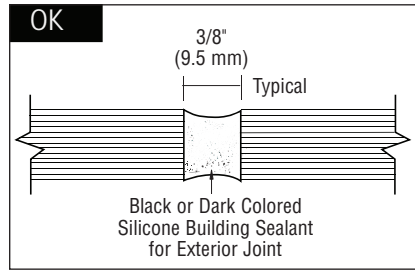

(1) Minimum 1/4" (6 mm) joint width; (2) Minimum 1/4" (6 mm) glass thickness; (3) Joint tooled into hourglass shape; (4) Dark-colored silicone building sealant is recommended (exterior).

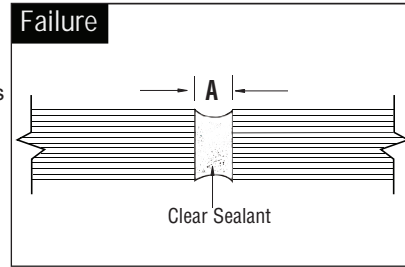

(1) Dimension A less than 1/4" (6 mm) resulting in inconsistent joint fill and very limited movement capabilities; (2) Clear sealants susceptible to yellowing from window cleaning chemicals, intersecting organic gaskets, and tobacco smoke; shows glass defects and bubbles.

Horizontal to Vertical Joint

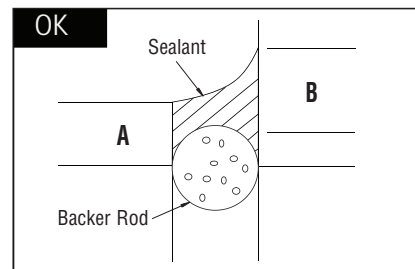

(1) Dimensions A and B are both greater than 1/4" (6 mm); (2) Sealant tooled to ensure positive runoff of water.

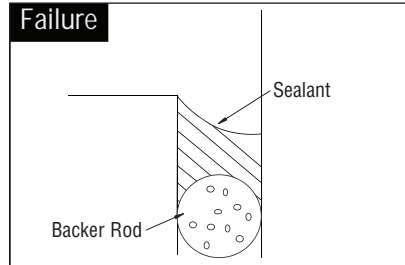

(1) Water could accumulate on top of the improperly tooled joint, increasing the chance of "pooling" and the probability of joint failure.

Moving Corner Joint

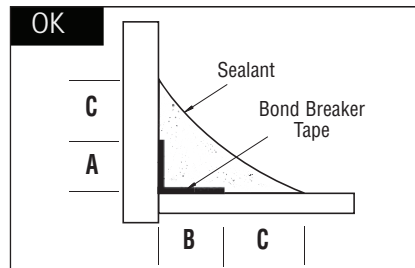

(1) Dimension A, B, and C must be at least 1/4" (6 mm); (2) A bond breaker tape or backer rod must be present if joint movement is anticipated; (3) Joint must be tooled into a concave surface; (4) Minimum sealant thickness of 1/8" (3 mm).

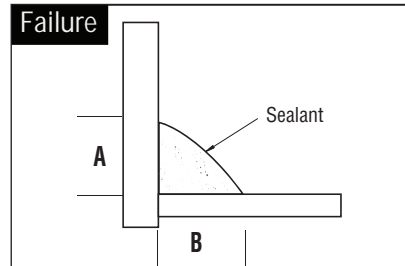

(1) Dimension A or B less than 1/4" (6 mm); (2) Joint not properly tooled into a concave surface; (3) No bond breaker material; therefore the joint will not accept movement.

Remedial Joints

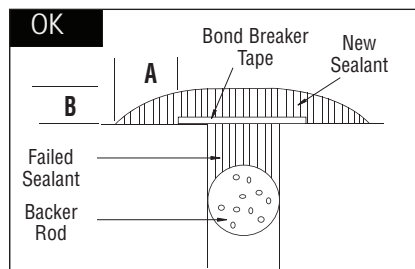

(1) Dimension A must be at least 1/4" (6 mm); (2) Dimension B must be at least 1/8" (3 mm) to a 3/8" (9.5 mm) maximum; (3) Bond breaker tape must be used to isolate fresh sealant from failed sealant.

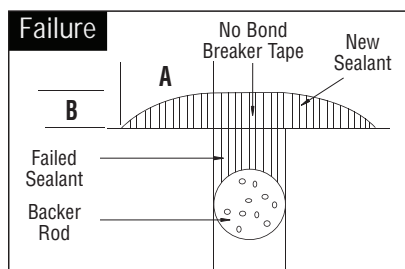

(1) Dimension A less than 1/4" (6 mm); difficulty in obtaining adhesion and increases the likelihood for gaps; (2) Dimension B less than 1/8" (3 mm): increases the likelihood of pinholes or voids in tooling; poor cohesive integrity. (3) No bond breaker tape: increases the chance that the sealant will tear when the underlying substrates move.

CRL Surface Preparation and Proper Application

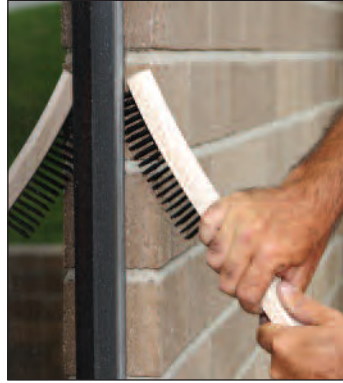

Mechanical Abrasion with Cat. No. 9553NB and LAB450



Cat. No. S1L2100 Silicone Primer

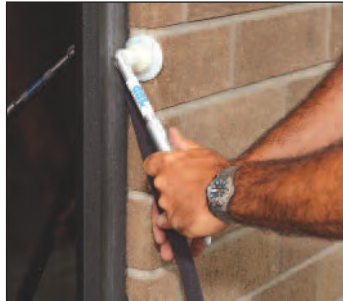
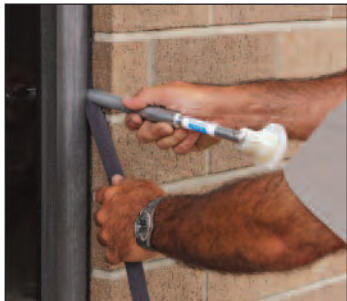

Pack Joint with Backer Rod Using Cat. No. SBRR Roller Tool

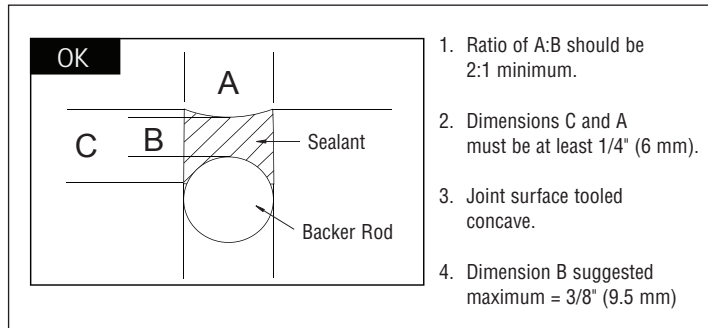

1. Clean Surface (Continued)

Porous substrates absorb liquid and include such building materials as EIFS, cement board panels, concrete, granite, limestone, and other stone or cementitious materials. Dusting alone may be sufficient, however, depending on the condition of the surface, abrasion cleaning, solvent cleaning, or both may be necessary. Laitance and surface dirt must be completely removed. Concrete form-release agents, water repellents, surface treatments, protective coatings, and old sealant all affect sealant adhesion. For proper removal, abrasion cleaning may be required to obtain acceptable adhesion.

Abrasion cleaning involves grinding, saw cutting, sand or water blasting, mechanical abrading, or a combination of these methods. Remaining dust and loose particles should be removed by dusting the surface with a stiff brush, vacuuming, or blowing the joints with oil-free compressed air. Once the abraded surface is clean and dry, the sealant can be applied. If the surface is dirty, the "two-cloth" cleaning method is again recommended. Some porous materials will trap solvents after cleaning or priming. Allow this solvent to evaporate before sealant is applied.

Most primers and sealants cannot be removed with organic solvents. Where aesthetics are important, be sure that uncured primers and sealants do not contact non-abradable surfaces in areas where the sealant is not intended. Mask these surfaces or use extreme care to prevent any contact with the surface during priming and sealant application.

2. Primer

Many sealants do not require a primer on properly cleaned substrates. Generally, priming will improve adhesion to any substrate, and is inexpensive insurance. When priming is recommended by the sealant manufacturer for specific substrates, use the following guideline.

Before applying the primer, be sure that the joint surfaces are clean and dry and that the proper surfaces are masked. Two different methods of primer application may then be used, depending on the substrate and job conditions. The preferred application is to dip a clean, dry, lint-free cloth into the primer and gently wipe a thin film onto the surface. A thin film of primer, applied with a clean brush is best for "hard-to-get-to" areas and rough surfaces such as EIFS. Be careful not to overprime, because this can cause adhesion loss between the sealant and the primer. Allow the primer to dry until all of the solvent evaporates. The surface is then ready for application of the backer rod and sealant. Sealant must be applied the same day the surfaces are primed. Any surfaces primed but not sealed on that same day must be re-cleaned and re-primed before applying the sealant.

3. Pack

When designing moving joints, a minimum 1/4" (6 mm) joint width is recommended. Wider joints accommodate more movement than narrow joints. Three-sided adhesion limits the amount of movement that a joint can accept without inducing a tear. (The rule of thumb is that no more than $\pm 15\%$ movement can be accommodated.)

Three-sided adhesion can be eliminated by adding a Backer Rod or a Bond Breaker Tape (see page N190).

CRL Surface Preparation and Proper Application



No Skin on Open Cell Backer Rod



Backer Rod Roller – Cat. No. SBRR

3. Pack (Continued)

Backer Rod is an integral part of the joint in which it is installed, and is available in a variety of diameters to accommodate different size joints. This backup material eliminates the need for a bond breaker, and helps control the depth of the sealant. Because the sealant does not bond to the rod, it can stretch and recover with joint movement, while minimal stress is put at the points of adhesion to the substrate. Bond Breaker Tape is usually used on joints too shallow for Backer Rods. It creates a two-sided adhesion, thereby allowing more joint movement.

A thin sealant joint [$1/4" \pm 1/8"$ (6 ± 3 mm) depth] will absorb more movement than a thick joint. Sealants are designed to deliver optimum performance when the joints are shaped like an hourglass. In this configuration, the sealant is gunned and tooled to be thinner in the middle and wider at the bonded sides, providing more stretching and recovery with joint movement. As a practical matter, as the sealant joint width becomes larger than 1" (25 mm), the depth should be held at approximately $3/8"$ (9.5 mm). There is no need to increase the depth beyond $3/8"$ (9.5 mm).

One-part sealants cure by taking moisture out of ambient air. Joint movement during cure can cause unsightly aesthetics due to joint wrinkling. Premature adhesion loss can also occur because the adhesive characteristics of the sealant are obtained after the sealant has cured. Adhesion loss due to movement during cure can be minimized by the use of a primer. Primers can decrease the adhesion cure time lag.

Minimize wrinkling by using Open Cell Polyurethane Backer Rod in vertical applications or non-exterior insulation finishing systems. This allows air and moisture to the back side of the one-part sealant. It is best to seal when the joint surface is cool and will experience minimum temperature changes, typically in the late afternoon or early evening.

Two-part sealants cure with the aid of a catalyst. Cure times are typically shorter, and wrinkling is usually not an issue.

4. Apply Sealant

It is critical that the sealant fills the entire joint or cavity and firmly contacts all surfaces intended to receive sealant. If the joint is improperly filled, good adhesion will not be achieved, and sealant performance will be weakened. To obtain full adhesion, sealants require a clean, dry, frost-free surface. Because frost formation can begin to occur below 4°C (40°F), it is best not to apply sealant at temperatures below that mark unless the frost is first removed using solvent when cleaning the surface. To assist in the drying of a frost-containing joint, a water-soluble solvent such as methyl ethyl ketone (MEK) or isopropyl alcohol (IPA) should be used.

Apply the sealant in a continuous operation, using a caulking gun or pump. Positive application pressure, adequate to fill the entire joint width, should be used. This can be accomplished by "pushing" the sealant ahead of the application nozzle. Be sure to completely fill the sealant cavity.

5. Tooling Sealant

Before a skin begins to form on the sealant, it must be tooled. There are several different types of tools available for this step, including Spatulas of different sizes and shapes and Stick Tools. Tooling forces the sealant against the back-up material and the joint surfaces. Tool the sealant with light pressure. At this point a concave configuration can be shaped at the top of the sealant, creating the recommended hourglass shape. Do not use liquid tooling aids such as water, soap, or isopropyl alcohol. These materials may interfere with sealant cure and adhesion, and may create aesthetic issues. Remove the masking tape before the sealant skins over.



CRL Sealant Requirement Estimator Chart

Spec Data, Material Safety Data Sheets and complete
Selector Charts are available at crlaurence.com

JOINT SIZE Depth x Width	APPROXIMATE LINEAR FEET (METERS) SEALED				
	Per 1 Gallon Container	Per 10.3 Fl. Oz. Cartridge	Per 20 Fl. Oz. Sausage	Per 2 Gallon Pail	Per 4.5 Gallon Pail
3/16" x 1/4" (4.8 x 6.3 mm)	411' (125 m)	33' (10 m)	64' (20 m)	821' (250 m)	1848' (563 m)
3/16" x 3/8" (4.8 x 9.5 mm)	274' (83 m)	22' (7 m)	43' (13 m)	548' (167 m)	1232' (376 m)
3/16" x 1/2" (4.8 x 12.7 mm)	205' (62 m)	16' (5 m)	32' (9.8 m)	411' (125 m)	924' (282 m)
3/16" x 5/8" (4.8 x 16 mm)	164' (50 m)	13' (4 m)	26' (8 m)	329' (100 m)	739' (225 m)
3/16" x 3/4" (4.8 x 19 mm)	137' (41 m)	11' (3.3 m)	21' (6 m)	274' (84 m)	616' (188 m)
1/4" x 1/4" (6.3 x 6.3 mm)	308' (94 m)	25' (8 m)	48' (15 m)	616' (188 m)	1386' (422 m)
1/4" x 3/8" (6.3 x 9.5 mm)	205' (62 m)	16' (4.9 m)	32' (9.8 m)	411' (125 m)	924' (282 m)
1/4" x 1/2" (6.3 x 12.7 mm)	154' (47 m)	12' (4 m)	24' (7.3 m)	308' (94 m)	693' (211 m)
1/4" x 5/8" (6.3 x 16 mm)	123' (37 m)	10' (3 m)	19' (5.8 m)	246' (75 m)	554' (169 m)
1/4" x 3/4" (6.3 x 19 mm)	103' (31 m)	8.3' (2.5 m)	16' (5 m)	205' (62 m)	462' (141 m)
1/4" x 1" (6.3 x 25 mm)	77' (23 m)	6.2' (1.9 m)	12' (3.6 m)	154' (47 m)	346' (105 m)
3/8" x 3/8" (9.5 x 9.5 mm)	137' (41 m)	11' (3.3 m)	21' (6 m)	274' (84 m)	616' (188 m)
3/8" x 1/2" (9.5 x 12.7 mm)	103' (31 m)	8.3' (2.5 m)	16' (4.9 m)	205' (62 m)	462' (141 m)
3/8" x 5/8" (9.5 x 16 mm)	82' (25 m)	6.6' (2 m)	13' (4 m)	164' (50 m)	370' (113 m)
3/8" x 3/4" (9.5 x 19 mm)	68' (21 m)	5.5' (1.7 m)	11' (3.3 m)	137' (41 m)	308' (94 m)
3/8" x 1" (9.5 x 25 mm)	51' (15.5 m)	4.1' (1.2 m)	7.9' (2.4 m)	103' (31 m)	231' (70 m)
3/8" x 1.5" (9.5 x 38 mm)	34' (10 m)	2.7' (.8 m)	5.3' (1.6 m)	68' (21 m)	154' (47 m)
3/8" x 2" (9.5 x 51 mm)	25' (8 m)	2' (.6 m)	3.9' (1.2 m)	51' (15.5 m)	115' (35 m)
3/8" x 3" (9.5 x 76 mm)	17' (5.1 m)	1.4' (.4 m)	2.6' (.8 m)	34' (10 m)	77' (23 m)
1/2" x 1/2" (12.7 x 12.7 mm)	77' (23 m)	6.2' (1.9 m)	12' (4 m)	154' (47 m)	346' (105 m)
1/2" x 5/8" (12.7 x 16 mm)	62' (19 m)	5' (1.5 m)	9.7' (2.9 m)	123' (37 m)	277' (84 m)
1/2" x 3/4" (12.7 x 19 mm)	51' (15.5 m)	4.1' (1.2 m)	8' (2.4 m)	103' (31 m)	231' (70 m)
1/2" x 1" (12.7 x 25 mm)	39' (12 m)	3.1' (.9 m)	6.1' (1.8 m)	77' (23 m)	173' (53 m)
1/2" x 1.5" (12.7 x 38 mm)	25' (8 m)	2' (.6 m)	3.9' (1.2 m)	52' (15.8 m)	115' (35 m)
1/2" x 2" (12.7 x 51 mm)	19' (5.8 m)	1.5' (.5 m)	3' (.9 m)	38' (11.5 m)	86' (26 m)
1/2" x 3" (12.7 x 76 mm)	12' (3.6 m)	1' (.3 m)	1.9' (.5 m)	26' (7.9 m)	58' (18 m)

Volume Equivalents:

25 Cartridges = one 2 gallon (7.6 liter) pail
 56 Cartridges = one 4.5 gallon (17 liter) pail
 Six 20 ounce Sausages = 1 gallon (less 8 ounces)

NOTE: Actual volume of sealant used will depend on factors such as joint design, backer rod placement, viscosity differences of various caulking materials, the tooling and rate at the job site.



CRL Construction Sealant Selector Chart

Spec Data, Material Safety Data Sheets and complete Selector Charts are available at crlaurence.com.

SEALANT	Primerless Adhesion to These Substrates	Dynamic Joint Movement	Hardness (Shore A)	Tack-Free Time	Tooling Time	Cure Time 1/4" (6 mm) Bead	Performance Temperature Range	Application Temperature Range	Conformance to ASTM and Federal Specification
CRL 33S Acetic Cure Silicone Sealant	Glass, Fiberglass, Plastics, Glazed Ceramic Tile, Porcelain, Painted Surfaces	± 25%	25	10 – 20 Minutes	5 – 8 Minutes	48 Hours	-80° to 400°F -62° to 204°C	-35° to 140°F -37° to 60°C	TT-S-001543A Class A; TT-S-00230C Class A; ASTM C-920; FDA; NSF, UL Recognized; Qualifies for LEED ®.
CRL WCS1 and WCS5 Water Clear Silicone Sealant	Glass, Fiberglass, Glazed Ceramic Tile, Porcelain, Painted Surfaces	± 25%	30	10 – 20 Minutes	5 – 8 Minutes	48 Hours	-80° to 400°F -62° to 204°C	-35° to 140°F -37° to 60°C	TT-S-001543A Class A; ASTM C-920; Qualifies for LEED ®.
CRL RTV408 Neutral Cure Silicone Sealant	Glass, Aluminum, Steel, Plastics, Glazed Ceramic Tile, Porcelain, Painted and Fluoropolymer Surfaces	± 25%	23	18 – 25 Minutes	10 – 15 Minutes	48 Hours	-80° to 400°F -62° to 204°C	-35° to 140°F -37° to 60°C	TT-S-001543A Class A; TT-S-00230C Class A; ASTM C-920; AAMA 802.3, 805.2, 808.3; Qualifies for LEED ®.
CRL 95C Neutral Cure Silicone Building Sealant	Glass, Aluminum, Steel, Plastics, Glazed Ceramic Tile, Porcelain, Painted and Fluoropolymer Surfaces	± 50%	25	30 – 35 Minutes	25 – 30 Minutes	48 Hours	-80° to 350°F -62° to 177°C	-20° to 140°F -29° to 60°C	TT-S-001543A Class A; TT-S-00230C Class A; ASTM C-920; Qualifies for LEED ®.
CRL M66 Polyurethane Construction Sealant	Concrete, Brick, Aluminum, Steel, Vinyl, Painted Metals, Natural Stones	± 25%	30	3 Hours	2.5 Hours	36 Hours	-40° to 200°F -40° to 93°C	-35° to 120°F -37° to 49°C	TT-S-00230C Class A; ASTM C-920; CAN/CGSB-19.13-M87 Qualifies for LEED ®.
CRL M64 Polyurethane Construction Sealant	Concrete, Brick, Aluminum, Steel, Vinyl, Painted Metals, Natural Stones	± 25%	25	3 Hours	2.5 Hours	36 Hours	-40° to 200°F -40° to 93°C	-35° to 120°F -37° to 49°C	TT-S-00230C Class A; ASTM C-920; AAMA 808.3; CAN/CGSB-19.13-M87; Qualifies for LEED ®.
CRL M65W Polyurethane Construction Sealant	Glass, Concrete, Brick, Aluminum, Steel, Vinyl, Painted Metals, Natural Stones, Many Plastics	± 25%	25	2 Hours	1 Hour	36 Hours	-40° to 200°F -40° to 93°C	-35° to 120°F -37° to 49°C	TT-S-00230C Class A; ASTM C-920; CAN/CGSB-19.13-M87; Qualifies for LEED ®.
CRL 777 Butyl Rubber Sealant	Glass, Metal, Concrete, Wood, Masonry, Some Plastics	± 7.5%	40	2 Hours	1 Hour	21 Days	-20° to 200°F -29° to 93°C	0° to 120°F -18° to 49°C	TT-S-001657 Type I; TT-C-1796A; ASTM C 1311; AAMA 808.3-05; USDA.
CRL 888 Butyl Rubber Sealant	Glass, Metal, Concrete, Wood, Masonry, Some Plastics	± 7.5%	40	2 Hours	1 Hour	21 Days	-20° to 200°F -29° to 93°C	0° to 120°F -18° to 49°C	TT-S-001657 Type I; TT-C-1796A; ASTM C 1311; AAMA 808.3-05; USDA.
CRL 321 Acrylic Latex with Silicone	Glass, Vinyl, Metal, Brick, Wood, Plastic, Ceramics, Drywall, Plaster	± 10%	45	15 Minutes	5-10 Minutes	72 Hours	40° to 120°F 4° to 49°C	0° to 180°F -18° to 82°C	ASTM C-834-00; ASTM C-920; TT-S-00230C; Qualifies for LEED ®.
CRL 800 Acrylic Latex with Silicone	Glass, Vinyl, Metal, Brick, Wood, Plastic, Ceramics, Drywall, Plaster	± 7.5%	40	15 Minutes	5-10 Minutes	72 Hours	40° to 120°F 4° to 49°C	0° to 180°F -18° to 82°C	ASTM C-834; Qualifies for LEED ®.
CRL15W Acrylic Latex Caulk	Aluminum, Masonry, Painted and Unpainted Wood, Drywall, Plaster	± 7.5%	50	15 Minutes	5-10 Minutes	72 Hours	40° to 120°F 4° to 32°C	-35° to 140°F -37° to 60°C	ASTM C-834; Qualifies for LEED ®.

CRL Comparable Sealant Brands Chart

Spec Data, Material Safety Data Sheets and complete Selector Charts are available at crlaurence.com.

CRL	DAP	DOW CORNING	GE (MOMENTIVE)	OSI
SILICONES				
CRL 33S	100% Silicone	999-A 732 700 Glazing General Purpose	1000 Contractors 1200 Construction	HM-270
CRL 33SMRC		786 Tub, Tile and Ceramic	1700 Sanitary	
CRL RTV408	TITANIUM®	799 Contractors Weatherproofing Vinyl Window, Siding & Door	Silglaze II 2800 Contractors-N 1800	VP-275
CRL 95C		791, 795	Silpruf	
POLYURETHANES				
CRL M64	Premium Polyurethane			PR-255
CRL M65W	SIDE WINDER®			
ACRYLIC LATEX				
CRL 321 or CRL 800	ALEX PLUS® ALEX Fast Dry™			SA-167 Polyseamseal
CRL 321	DYNAFLEX 230®			Pro-Stik
CRL15W	ALEX® Painters RELY-ON®			LC-160
BUTYL RUBBERS				
CRL 888 or CRL 777	BUTYL-FLEX®			SBR-100
CRL	PECORA	SIKA	SONNEBORN	TREMCO
SILICONES				
CRL 33S	860 863	SikaSil®-GP	OmniPlus	Proglaze Tremsil 200 TremPro 644
CRL RTV408	896	SikaSil®-N Plus		Tremsil 600 TremPro 645
CRL 95C	864 895	SikaSil®-WS95	OmniSeal	Spectrem 2 Spectrem 3
POLYURETHANES				
CRL M64	Dynatrol® 1-XL	Sikaflex® 1A Sikaflex®-201 US Sikaflex® 15LM Sikaflex®-219 LM	NP1	Dymonic Vulkem 921 TremGlaze U1400
CRL M66		Sikaflex®-201 Textured		Vulkem 116 TremPro 626
CRL M65W	Pro-Sil 1		Sonolastic 150	TremGlaze 41600
ACRYLIC LATEX				
CRL 321 or CRL 800	AC-20+		Sonolac	834 TremGlaze SA1100 TremPro 655
BUTYL RUBBERS				
CRL 888 or CRL 777	BC-158			Butyl Sealant

LEED® (Leadership in Energy and Environmental Design) Statement for CRL Sealants, Adhesives, and Glazing Tapes

More and more new building projects are classified as "Green" or "Environmentally Friendly", and provide LEED® credits for reducing air contaminants.

What is LEED®?

LEED® is a third party certification program and the nationally accepted benchmark for the design, construction, and operation of high performance "green" buildings. Developed by the U.S. Green Building Council in 2000 through a consensus based process, LEED® serves as a tool for buildings of all types and sizes. LEED® certification offers third party validation of a project's "green" features, and verifies that the building is operating exactly the way it was designed to.

How does LEED® work?

LEED® is a point-based system where building projects earn LEED® points for satisfying specific "green" building criteria. Within each of the LEED® credit categories, projects must satisfy particular prerequisites and earn points. The five categories include Sustainable Sites (SS), Water Efficiency (WE), Energy and Atmosphere (EA), Materials and Resources (MR), and Indoor Environmental Quality (IEQ). An additional category, Innovation in Design (ID), addresses sustainable building expertise as well as design measures not covered under the five environmental categories. The number of points the project earns determines the level of LEED® Certification the project receives.

Credit 4.1 Indoor Environmental Quality (IEQ) is given for using Low-Emitting Materials, Adhesives, and Sealants. The intent is to reduce the quantity of indoor air contaminants that are odorous, potentially irritating, and/or harmful to the comfort and well-being of installers and occupants. The Volatile Organic Compounds (VOC) content of adhesives and sealants used must be less than the current VOC content limits of South Coast Air Quality Management District (SCAQMD) Rule # 1168 requirements, and the Bay Area Air Quality Management District Regulation 9 (BAAQMD) Rule 51 requirements. CRL Sealant VOC values fall below the applicable VOC limit listed within this credit, which is 250 g/L (grams/liter). In addition, all of our Polyurethane Sealants and Adhesives (M64, M66, and M65W) are TDI free compared to most competitors' products. Our Polyurethanes are formulated from the safer, less toxic MDI based polymer.

Credit 5.1 Materials and Resources (MR) is given for using Local/Regional Materials. The intent is to increase demand for building products that are manufactured locally, thereby reducing the environmental impacts resulting from their transportation and supporting the local economy. Credit is given to products manufactured within 500 miles of the building site location. The manufacturing site for our sealants listed below (except if otherwise noted) is Lakewood, NJ 08701. Confirm your site is within a 500 mile radius of the manufacturing site.

CRL Sealants

33S Silicone	<39 g/L
RTV408 Industrial and Construction Silicone	<39 g/L
95C Silicone Building Sealant	<25 g/L
WCS1 Water Clear Silicone	<36 g/L
M64 Polyurethane Construction Sealant	<33 g/L
M66 Polyurethane Construction Sealant	<33 g/L
M65W PermaWhite Sealant	<23 g/L
321 Acrylic Latex with Silicone (Mfg. site is Pryor, OK 74361)	<19 g/L
CRL15W Acrylic Latex Caulk (Mfg. site is Pryor, OK 74361)	30-40 g/L
800 Acrylic Latex with Silicone (Mfg. site is Dallas, TX 75243)	31 g/L

VOC Value

CRL Adhesives

UV770, UV740, UV678, UV682, UV665, UV690, UV760, and Colored UV Adhesives (Mfg. site is Winsted, CT 06098)	0 g/L
---	-------

CRL Mastics

600GL Heavy Bodied Mirror Mastic (Mfg. site is Louisville, KY 40207)	230 g/L
---	---------

CRL Tapes

980 Series Vinyl Foam Glazing Tape – Adhesive Two Sides	<5 g/L
740 Series Vinyl Foam Glazing Tape – Adhesive One Side (Mfg. site is San Antonio, TX 78218)	<5 g/L
V2100 Thermalbond™ Structural Glazing Spacer Tape (Mfg. site is Granville, NY 12832)	<6.5 g/L
GT Series Butyl Architectural Tape (Mfg. site is Evansville, IN 47711)	0 g/L

Additional LEED® information is available on the U.S. Green Building Council web site at usgbc.org

LEED® is a registered trademark of the U.S. Green Building Council.

Surface Preparation Guide for CRL Silicone Sealants *Non-Structural Use Only



Optimum performance of CRL Sealants depends on proper surface preparation and often the use of a primer. As in all cases, the chosen substrate should be tested for adhesion and compatibility prior to sealant application.

SUBSTRATE	Surface Preparation	CRL 33S		CRL RTV408		CRL 95C	
		Recommendation	Primer	Recommendation	Primer	Recommendation	Primer
GLASS							
Insulating	Solvent Wipe ³	Do not use		OK	None Req.	OK	None Req.
Float, Plate, Sheet	Solvent Wipe	OK	None Req.	OK	None Req.	OK	None Req.
Laminated ⁴	Solvent Wipe	OK	None Req.	OK	None Req.	OK	None Req.
Tinted	Solvent Wipe	OK	None Req.	OK	None Req.	OK	None Req.
Porcelain-Coated Material	Solvent Wipe	OK	None Req.	OK	None Req.	OK	None Req.
Ceramic Tile, Glazed	Solvent Wipe	OK	None Req.	OK	None Req.	OK	None Req.
Vitrified Surfaces	Solvent Wipe	OK	None Req.	OK	None Req.	OK	None Req.
Reflective Glass	Solvent Wipe	Call CRL		OK	None Req.	OK	None Req.
Low (E) High (T) Glass	Solvent Wipe	Call CRL		OK	None Req.	OK	None Req.
CONCRETE & MASONRY¹							
Brick	Abrade ²	Do not use		OK	S1L2100	OK	None Req.
Concrete Block	Abrade	Do not use		OK	S1L2100	OK	S1L2100
Poured Concrete	Abrade	Do not use		OK	S1L2100	OK	S1L2100
Precast Concrete	Abrade	Do not use		OK	S1L2100	OK	S1L2100
Tilt-Up Concrete	Abrade	Do not use		OK	S1L2100	OK	S1L2100
Mortar	Abrade	Do not use		OK	S1L2100	OK	S1L2100
Grout	Abrade	Do not use		OK	S1L2100	OK	S1L2100
Plaster	Abrade	Do not use		OK	S1L2100	OK	S1L2100
STONE¹							
Travertine	Abrade/Solvent Wipe	Do not use		OK	S1L2100	OK	S1L2100
Granite	Abrade/Solvent Wipe	Do not use		OK	S1L2100	OK	None Req.
Marble	Abrade/Solvent Wipe	Do not use		OK	S1L2100	OK	S1L2100
Limestone	Abrade/Solvent Wipe	Do not use		OK	S1L2100	OK	S1L2100
Sandstone	Abrade/Solvent Wipe	Do not use		OK	S1L2100	OK	S1L2100
PAINTS							
Acrylic Latex	Solvent Wipe	OK	S1L2100	OK	None Req.	OK	None Req.
Acrylic Thermoset	Solvent Wipe	OK	S1L2100	OK	None Req.	OK	None Req.
Silicone Alkyd	Solvent Wipe	OK	None Req.	OK	None Req.	OK	None Req.
Silicone Acrylic	Solvent Wipe	OK	None Req.	OK	None Req.	OK	None Req.
Polyurethane	Solvent Wipe	OK	None Req.	OK	None Req.	OK	None Req.
Polyvinyl Chloride (PVC)	Solvent Wipe	OK	S1L2100	OK	S1L2100	OK	None Req.
Silicone Polyester	Solvent Wipe	OK	None Req.	OK	None Req.	OK	None Req.
FLOUROPOLYMER							
KYNAR®	Solvent Wipe	OK	S1L2100	OK	None Req.	OK	None Req.
DURANAR®	Solvent Wipe	OK	S1L2100	OK	None Req.	OK	None Req.
FLUOROPON®	Solvent Wipe	OK	S1L2100	OK	None Req.	OK	None Req.
DURANAR XL®	Solvent Wipe	OK	S1L2100	OK	None Req.	OK	None Req.
PLASTICS							
Acrylic Sheet	Solvent Wipe	OK	S1L2100	OK	S1L2100	OK	None Req.
Polyester/Fiberglass	Solvent Wipe	OK	None Req.	OK	None Req.	OK	None Req.
Epoxy Aggregate Panels	Solvent Wipe	OK	None Req.	OK	None Req.	OK	None Req.
Polycarbonate Sheet	Solvent Wipe	OK	S1L2100	OK	S1L2100	OK	None Req.
Polystyrene	Solvent Wipe	OK	None Req.	OK	None Req.	OK	None Req.
Polyvinyl Chloride	Solvent Wipe	OK	S1L2100	OK	S1L2100	OK	None Req.
Polyester Aggregate Panel	Solvent Wipe	OK	None Req.	OK	None Req.	OK	None Req.

Surface Preparation Guide for CRL Silicone Sealants *Non-Structural Use Only



Optimum performance of CRL Sealants depends on proper surface preparation and often the use of a primer. As in all cases, the chosen substrate should be tested for adhesion and compatibility prior to sealant application.

SUBSTRATE	Surface Preparation	CRL 33S		CRL RTV408		CRL 95C	
		Recommendation	Primer	Recommendation	Primer	Recommendation	Primer
RUBBER							
Butyl	Solvent Wipe	Test	None Req.	Test	None Req.	OK	None Req.
EPDM	Solvent Wipe	Test	None Req.	Test	None Req.	OK	None Req.
Neoprene	Solvent Wipe	Test	None Req.	Test	None Req.	OK	None Req.
Polyurethane	Solvent Wipe	Test	None Req.	Test	None Req.	OK	None Req.
Acrylic	Solvent Wipe	Test	None Req.	Test	None Req.	OK	None Req.
Vinyl	Solvent Wipe	Test	None Req.	Test	None Req.	OK	None Req.
Silicone Rubber	Solvent Wipe	OK	None Req.	OK	None Req.	OK	None Req.
METALS							
Aluminum – Alodine	Solvent Wipe	OK	S1L2100	OK	None Req.	OK	None Req.
Aluminum – Mill Finish	Abrade/Solvent Wipe	OK	S1L2100	OK	S1L2100	OK	None Req.
Aluminum – Anodized	Solvent Wipe	OK	S1L2100	OK	None Req.	OK	None Req.
Copper	Abrade/Solvent Wipe	Do not use		Do not use		OK	S1L2100
Lead	Abrade/Solvent Wipe	Do not use		OK	None Req.	OK	None Req.
STEEL							
Red Lead Primer	Solvent Wipe	OK	S1L2100	OK	None Req.	OK	None Req.
Weathered	Abrade/Solvent Wipe	OK	S1L2100	OK	None Req.	OK	None Req.
Stainless	Solvent Wipe	OK	S1L2100	OK	None Req.	OK	None Req.
Galvanized	Solvent Wipe	OK	S1L2100	OK	None Req.	OK	None Req.
Cold Rolled	Solvent Wipe	OK	S1L2100	OK	None Req.	OK	None Req.
WOODS							
Unfinished	Solvent Wipe	OK	S1L2100	OK	None Req.	OK	None Req.
Finished	Solvent Wipe	Refer to PAINTS Section		Refer to PAINTS Section		Refer to PAINTS Section	

*These recommendations apply for weatherseal applications only, and are NOT intended for structural glazing applications.

¹Job specific stain testing should be done for both sealant or primer because masonry and stone porosity varies.

²Abrade = Mechanical surface preparation such as wire brush or sand blast. Should always be followed by residual dust removal.

³Solvent wipe = Wipe with clean, oil-free rag; wet with industrial solvent such as mineral spirits, naphtha, isopropyl alcohol (IPA), or ketones (MEK or MIBK). Test small sample to ensure solvent does not affect finish. Allow surface to thoroughly dry before applying sealant.

CAUTION: When using solvents or primers always provide adequate ventilation and keep away from heat, sparks, and open flames. Follow all precautions given on the solvent container label and Material Safety Data Sheet. Additionally, always check compatibility of substrate with cleaning solvent or primer before full-scale use. Follow local, state, and federal regulations for solvent use.

⁴Laminated glass with polyvinyl butrol (PVB) interlayers may delaminate up to 1/4" (6 mm) when in contact with a sealant.

SPECIAL NOTE: We no longer carry Cat. No. 99AS Aquarium Silicone Sealant due to circumstances beyond our control. In addition, it is not our intent to carry any aquarium sealant in the future. We apologize for any inconvenience this may cause any of our customers.